



RT8024

1.5A 1.5MHz Synchronous Buck Converter

DESCRIPTION

The RT8024 is a high-efficiency monolithic synchronous buck regulator using a constant frequency, current mode architecture. The device is available in an adjustable version. Supply current with no load is 40uA and drops to <1uA in shutdown. The 2.5V to 6V input voltage range makes the RT8024 ideally suited for single Li-Ion battery powered applications. 100% duty cycle provides low dropout operation, extending battery life in portable systems. PWM/PFM mode operation provides very low output ripple voltage for noise sensitive applications.

Switching frequency is internally set at 1.5MHz, allowing the use of small surface mount inductors and capacitors. Low output voltages are easily supported with the 0.6V feedback reference voltage.

The RT8024 is available in SOT23-5 package.

FEATURES

- High Efficiency: Up to 96%
- 2.5V to 6V Input Voltage Range
- 1.5MHz Constant Frequency Operation
- No Schottky Diode Required
- Low Dropout Operation:100% Duty Cycle
- PFM Mode for High Efficiency in Light Load
- Over temperature Protected
- Low Quiescent Current: 40μA
- Short Circuit Protection
- Inrush Current Limit and Soft Start
- Available in SOT23-5

APPLICATIONS

- Cellular and Smart Phones
- Wireless and DSL Modems
- PDAs
- Portable Instruments
- Digital Still and Video Cameras
- PC Cards

TYPICAL APPLICATION

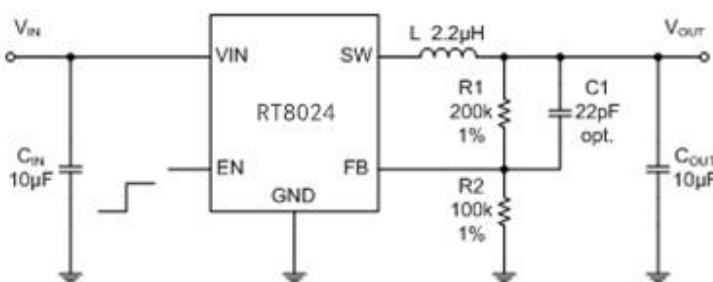

PIN OUT & MARKING

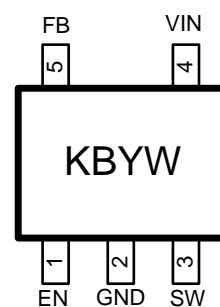

SOT23-5

KB: Product Code

YW: Date code (Year & Week)

ORDERING INFORMATION

PART No.	PACKAGE	Tape&Reel
RT8024	SOT23-5	3000/Reel

ABSOLUTE MAXIMUM RATING

Parameter	Value
Max Input Voltage	8V
Max Operating Junction Temperature(Tj)	125°C
Ambient Temperature(Ta)	-40°C – 85°C
Maximum Power Dissipation SOT23-5	400mW
Storage Temperature(Ts)	-40°C - 150°C
Lead Temperature & Time	260°C, 10S

Note: Exceed these limits to damage to the device. Exposure to absolute maximum rating conditions may affect device reliability.

ELECTRICAL CHARACTERISTICS

(Vin=VEN=3.6V, TA=25°C)

Symbol	Parameter	Conditions	Min	Typ	Max	Unit
Vin	Input Voltage Range		2.5		6	V
Vref	Feedback Voltage		0.588	0.6	0.612	V
Iq	Quiescent Current	FB = 90%, Vin=5.0V, Iload=0mA		150	300	uA
		FB= 105%, Vin=5.0V, Iload=0mA		40	70	uA
		V _{EN} = 0V, Vin=4.2V		0.1	1.0	uA
LnReg	Line Regulation	Vin=2.5V to 6V		0.1	0.2	%/V
LdReg	Load Regulation			0.5		%
Fsoc	Switching Frequency			1.5		MHz
RdsonP	PMOS Rdson	I _{sw} =100mA		300		mohm
RdsonN	NMOS Rdson	I _{sw} =-100mA		200		mohm
Ilimit	Peak Current Limit	Vin=5V, Vout=3.3V		2.2		A
Inoload*		Vin=5V, Vout=3.3V, Iout=0		43		uA
Iswlk	SW Leakage Current	V _{EN} =0V, Vin=Vsw=5V			1	uA
Ienlk	EN Leakage Current				1	uA
Vh_en	EN Input High Voltage		1.04			V
Vl_en	EN Input Low Voltage				0.98	V

Note: *When Duty cycle >90%, Inoload will increase. e.g. Vin=3.5V/Vout=3.3V, Inoload=800uA.

PIN DESCRIPTION

PIN #	NAME	DESCRIPTION
1	EN	Chip Enable Pin. Drive EN above 1.5V to turn on the part. Drive EN below 0.3V to turn it off. Do not leave EN floating.
2	GND	Ground
3	SW	Power Switch Output. It is the switch node connection to Inductor. This pin connects to the drains of the internal P-ch and N-ch MOSFET switches.
4	VIN	Supply voltage. Must be closely decoupled to GND with a 10μF or greater ceramic capacitor.
5	FB	Output Voltage Feedback Pin. An internal resistive divider divides the output voltage down for comparison to the internal reference voltage.

ELECTRICAL PERFORMANCE

Tested under $T_A=25^{\circ}\text{C}$, unless otherwise specified

Efficiency vs. Output Current
($V_{out}=1.2\text{V}$)

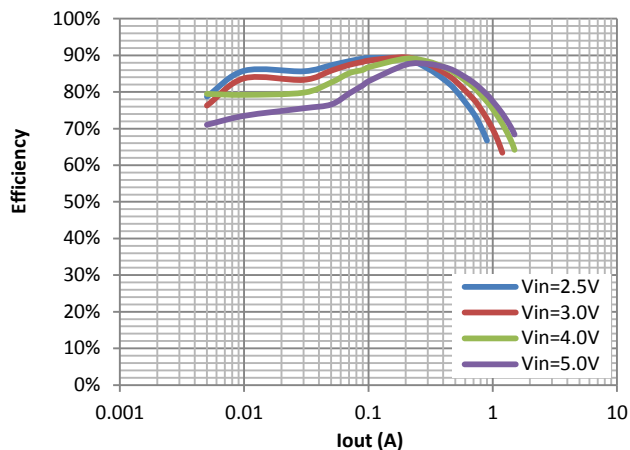

Efficiency vs. Output Current
($V_{out}=1.8\text{V}$)

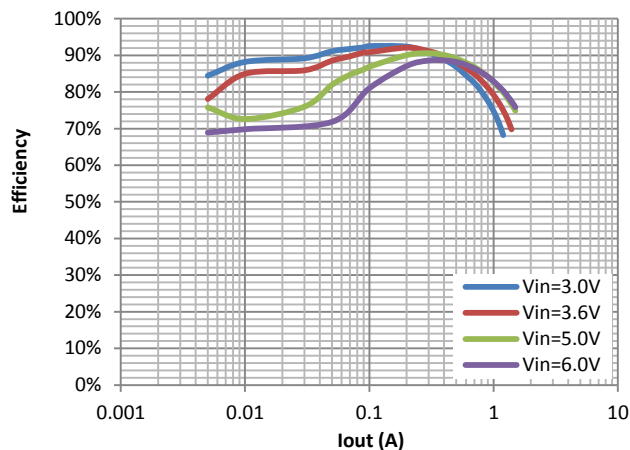

Efficiency vs. Output Current
($V_{out}=3.3\text{V}$)

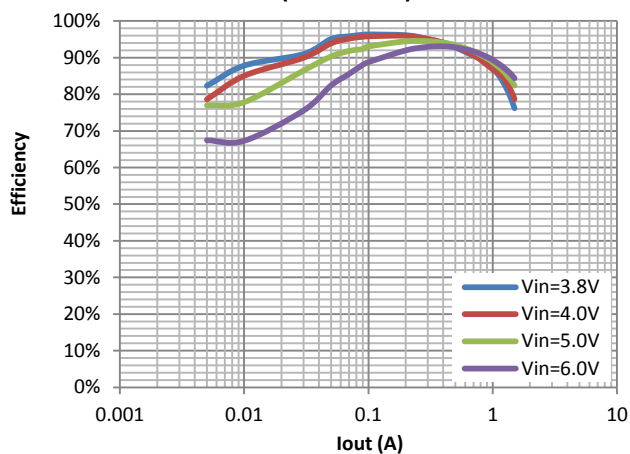

Output Ripple and SW at 1.5A load
 $V_{in}=5\text{V} / V_{out}=3.3\text{V}$

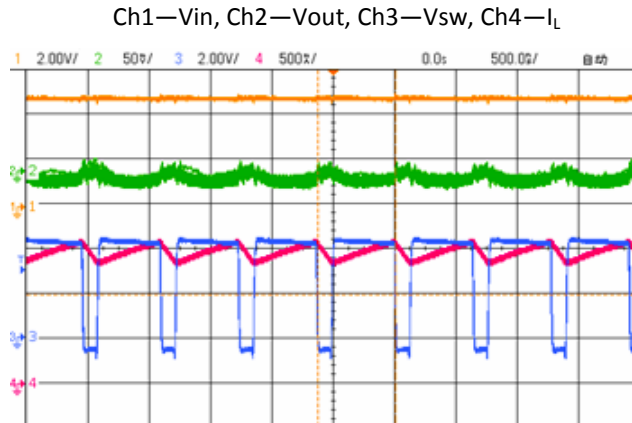

BLOCK DIAGRAM

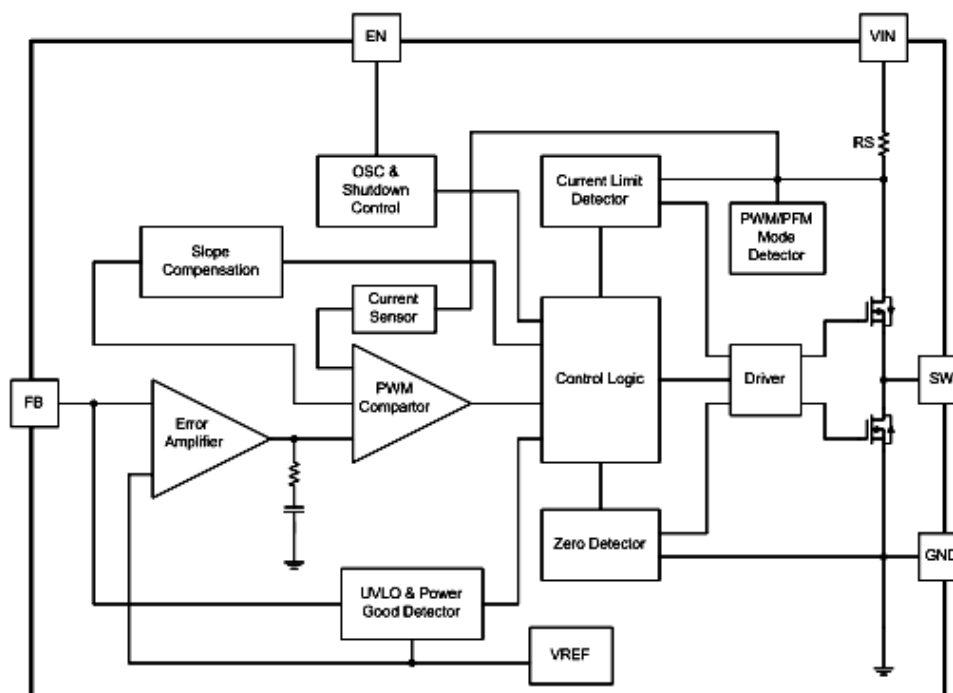

DETAILED DESCRIPTION

The RT8024 uses a constant frequency, current mode step-down architecture. Both the main (P-channel MOSFET) and synchronous (N-channel MOSFET) switches are internal. During normal operation, the internal top power MOSFET is turned on each cycle when the oscillator sets the RS latch, and turned off when the current comparator, ICOMP, resets the RS latch. The peak inductor current at which ICOMP resets the RS latch, is controlled by the output of error amplifier EA. When the load current increases, it causes a slight decrease in the feedback voltage, FB, relative to the 0.6V reference, which in turn, causes the EA amplifier's output voltage to increase until the average inductor current matches the new load current. While the top MOSFET is off, the bottom MOSFET is turned on until either the inductor current starts to reverse, as indicated by the current reversal comparator IRCMP, or the beginning of the next clock cycle.

APPLICATIONS INFORMATION

Setting the Output Voltage

In the adjustable version, the output voltage is set by a resistive divider according to the following formula:

$$R_2 = \frac{R_1}{V_{out} / V_{FB} - 1}$$

The external resistive divider is connected to the output, allowing remote voltage sensing as shown in on page 1 .

Inductor Selection

For most designs, the Y3410 operates with inductors of 1μH to 4.7μH. Low inductance values are physically smaller but require faster switching, which results in some efficiency loss. The inductor value can be derived from the following equation:

$$L = \frac{V_{OUT} \times (V_{IN} - V_{OUT})}{V_{IN} \times \Delta I_L \times f_{OSC}}$$

Where ΔI_L is inductor Ripple Current. Large value inductors result in lower ripple current and small value inductors result in high ripple current. For optimum voltage-positioning load transients, choose an inductor with DC series resistance in the 50mΩ to 150mΩ range.

Input Capacitor Selection

Higher values, lower cost ceramic capacitors are now becoming available in smaller case sizes. Their high ripple current, high voltage rating and low ESR make them ideal for switching regulator applications. Because the RT8024's control loop does not depend on the output capacitor's ESR for stable operation, ceramic capacitors can be used freely to achieve very low output ripple and small circuit size. However, care must be taken when ceramic capacitors are used at the input and the output. When a ceramic capacitor is used at the input and the power is supplied by a wall adapter through long wires, a load step at the output can induce ringing at the input, VIN. At best, this ringing can couple to the output and be mistaken as loop instability. At worst, a sudden inrush of current through the long wires can potentially cause a voltage spike at VIN, large enough to damage the part. When choosing the input and output ceramic capacitors, choose the X5R or X7R dielectric

formulations. These dielectrics have the best temperature and voltage characteristics of all the ceramics for a given value and size.

PC Board Layout Checklist

When laying out the printed circuit board, the following checking should be used to ensure proper operation of the RT8024. Check the following in your layout:

- 1) The power traces, consisting of the GND trace, the SW trace and the VIN trace should be kept short, direct and wide.
- 2) Does the (+) plates of Cin connect to Vin as closely as possible? This capacitor provides the AC current to the internal power MOSFETs.
- 3) Keep the switching node, SW, away from the sensitive VOUT node.
- 4) Keep the (-) plates of Cin and Cout as close as possible

PACKAGE OUTLINE

Package	SOT23-5	Devices per reel	3000	Unit	mm
Package specification:					
<p>The drawing shows the SOT23-5 package with the following dimensions:</p> <ul style="list-style-type: none"> Overall width: 2.9 ± 0.2 mm Distance between pins 1 and 5: 1.9 ± 0.2 mm Pin pitch (between pins 1-2, 2-3, 3-4, 4-5): 0.95 mm Pin 1 width: 0.4 ± 0.1 mm Pin 2 width: 0.4 ± 0.1 mm Pin 3 width: 0.4 ± 0.1 mm Pin 4 width: 0.4 ± 0.1 mm Pin 5 width: 0.4 ± 0.1 mm Maximum height: 2.8 ± 0.3 mm Maximum height at pin 1: 1.6 ± 0.1 mm Maximum height at pin 5: 1.6 ± 0.1 mm Side view dimensions: <ul style="list-style-type: none"> Pin 1 height: 1.1 ± 0.2 mm Pin 2 height: 0.8 ± 0.1 mm Pin 3 height: 0.8 ± 0.1 mm Pin 4 height: 0.8 ± 0.1 mm Pin 5 height: 0.8 ± 0.1 mm Lead thickness: 0.15 ± 0.1 mm Lead width: 0.15 ± 0.1 mm Lead angle: 0.2 MIN. 					